

Prénom :

## Construire les 1ers outils pour structurer sa pensée

Compétences : Réaliser une collection dont le cardinal est donné.

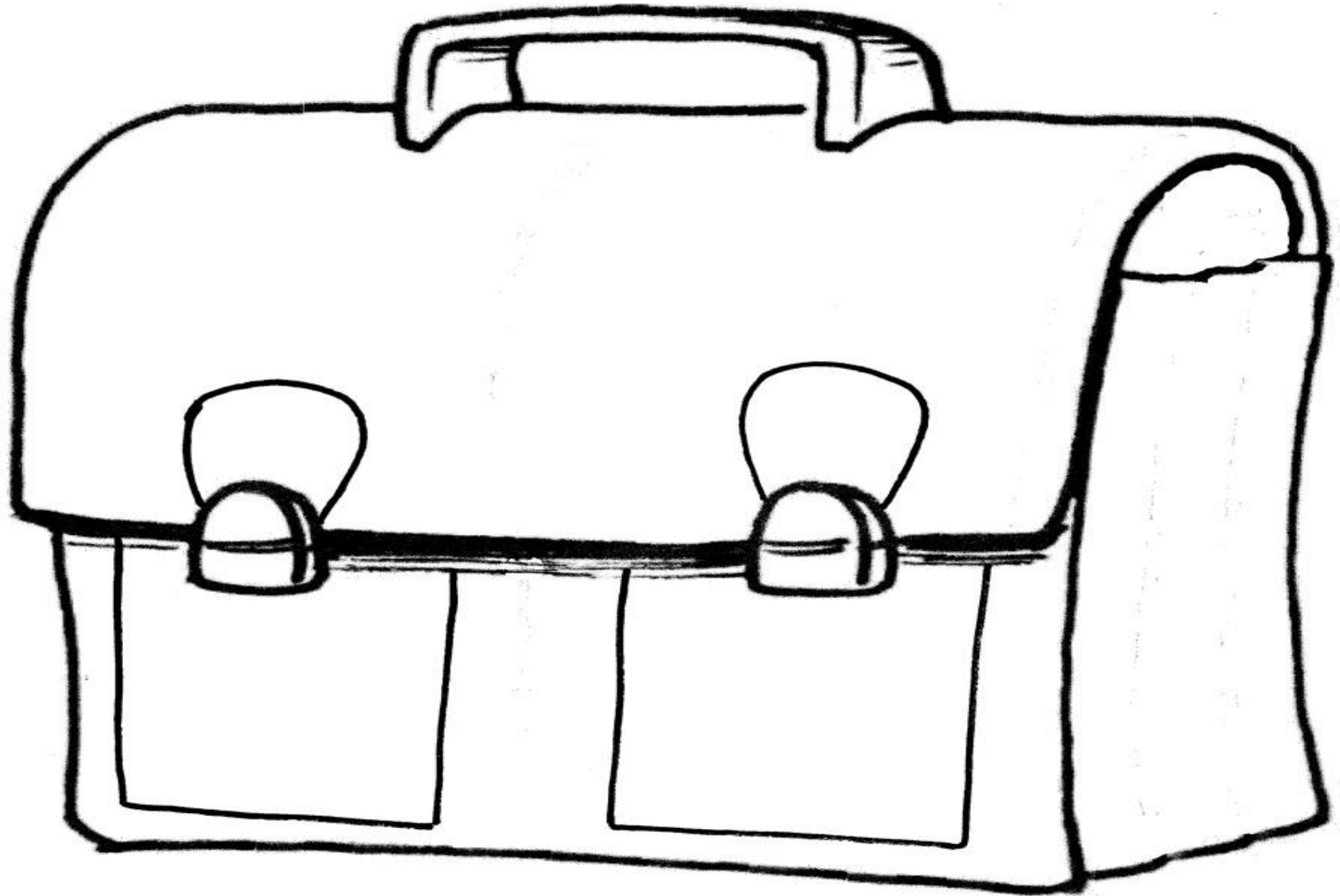



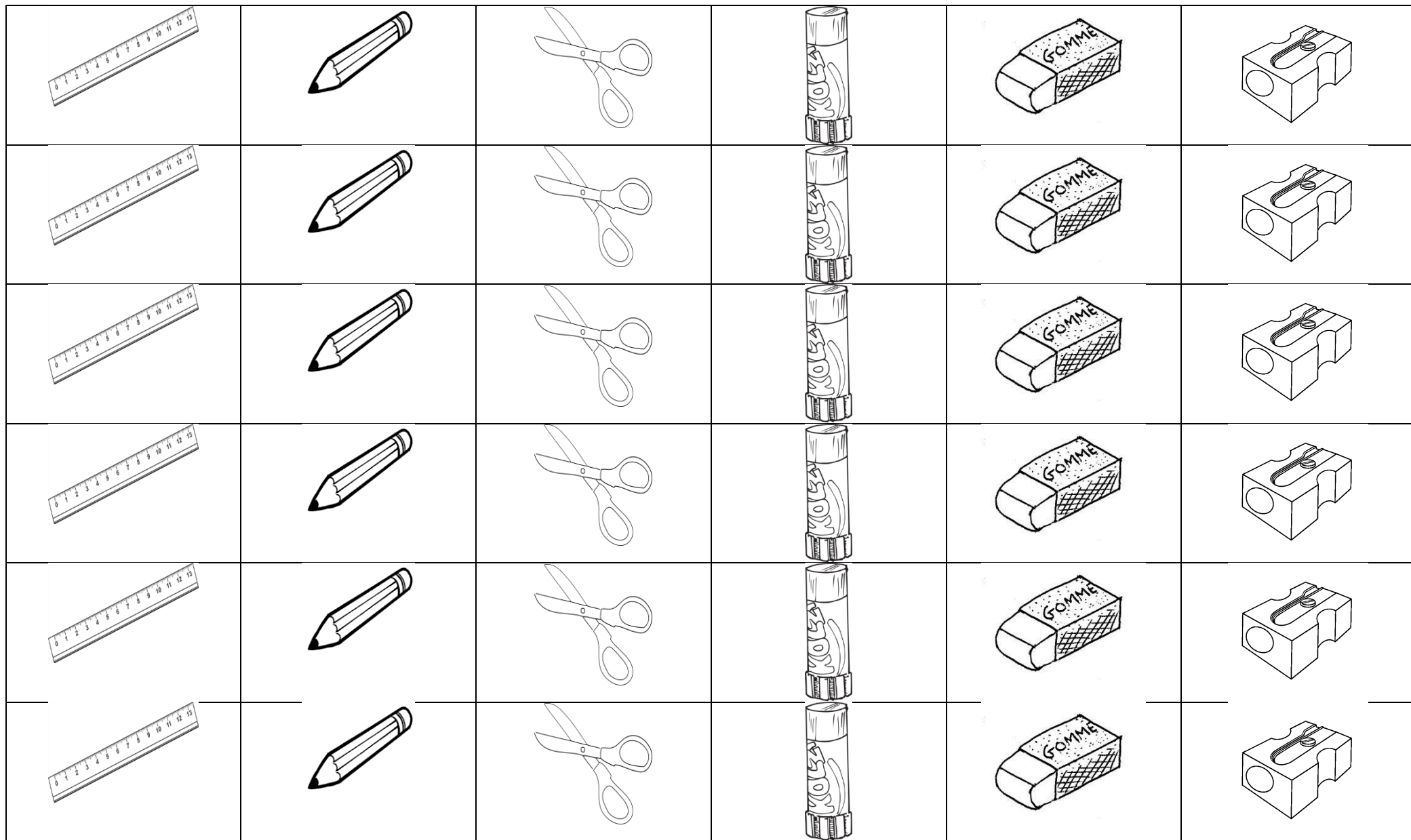



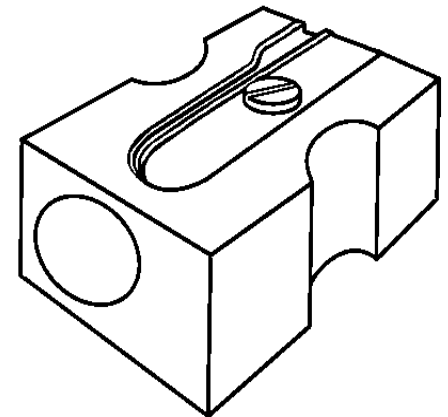
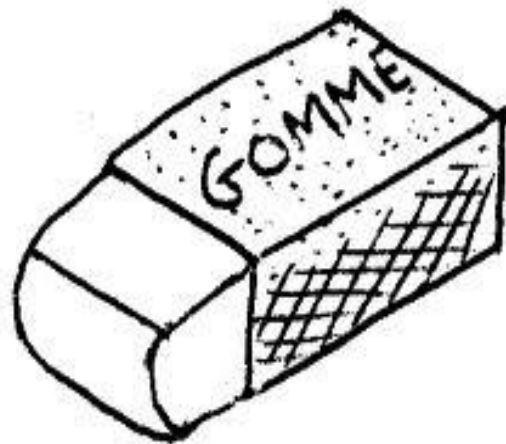
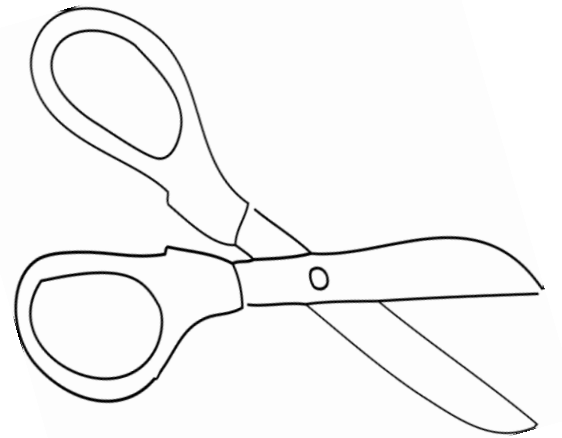
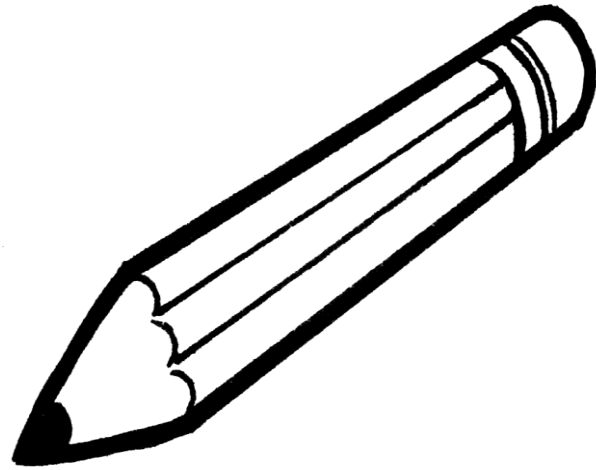
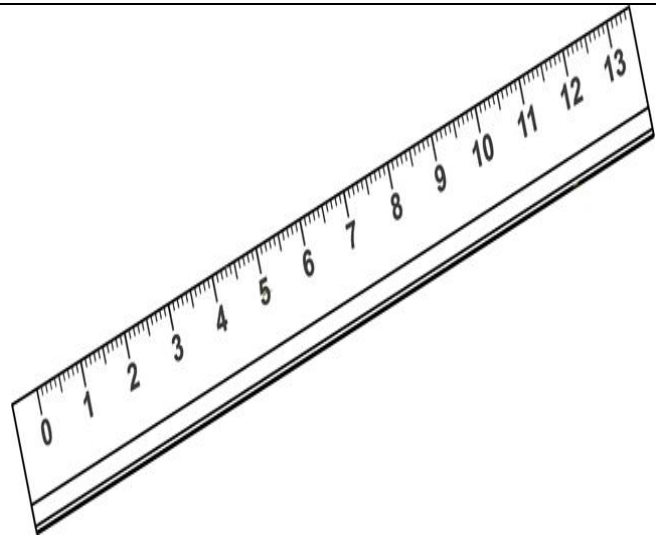



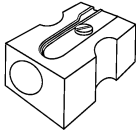

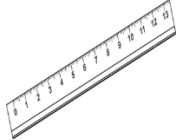



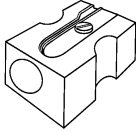

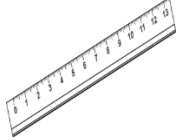



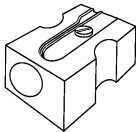

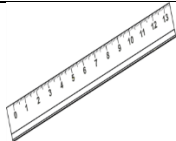



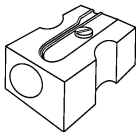

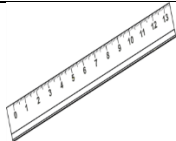

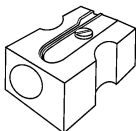

Consigne : Place dans le cartable le nombre de fournitures demandées par la maitresse.

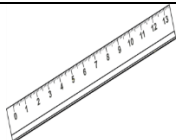

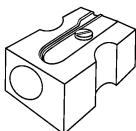

Matériel à photocopier 3 X et plastifier pour exo de manipulation

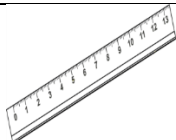

						
	1	4	2	0	5	3
						
	0	2	4	1	3	5
						
	3	0	1	5	2	4
						
	2	3	5	4	0	1
						
	1	3	0	2	0	4
						
	5	2	0	3	4	1

Bon de commande pour 6 élèves